

Crystal Growth: Physics, Technology and Modeling

Stanisław Krukowski & Michał Leszczyński

Institute of High Pressure Physics PAS

01-142 Warsaw, Sokołowska 29/37

e-mail: stach@unipress.waw.pl, mike@unipress.waw.pl

Zbigniew Żytkiewicz

Institute of Physics PAS

02-668 Warsaw, Al. Lotników 32/46

E-mail: zytkie@ifpan.edu.pl

Lecture 1. Thermodynamic equilibrium

<http://www.unipress.waw.pl/~stach/cg-2024-25>

Thermodynamic equilibrium and nonequilibrium

Thermodynamic parameters – parameters describing state of the system:

- Extensive - proportional to the system size, i.e. $A \sim N$ $N \rightarrow \infty$ N, V, U, F, G
- Intensive - independent of the system size, i.e. $a \sim \text{const}(N)$ $N \rightarrow \infty$ $p, \rho, \varepsilon, T,$

Equilibrium state – state of the system, independent of the time, such that introduction of internal borders does not change its behavior

We consider **deviation** of the system from equilibrium state by the action of the factors **external** to the system

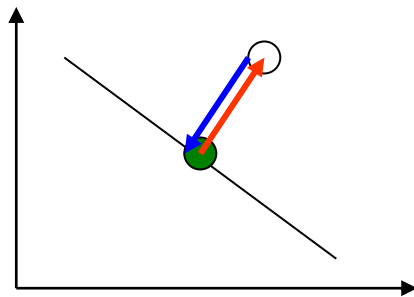

$$U = U_{eq} + \delta U$$

$$\delta U = U - U_{eq}$$

$$T = T_{eq} + \delta T$$

$$\delta T = T - T_{eq}$$

These changes are enforced by external factors.

System **return** to the equilibrium state without any factors **external** to the system $(-\delta U)$ $(-\delta T)$

Thermodynamic stability - the system returns to the initial state **spontaneously**.

Thermodynamic stability

Thermodynamic stability is based on second law of thermodynamics in Clausius' formulation, i.e. Clausius inequality

$$(-T\delta S) \geq (-\delta Q)$$

The system returns to equilibrium state spontaneously, i.e. is thermodynamically stable if the Clausius inequality is fulfilled.

First law of thermodynamics is always fulfilled:

$$\delta U = -p\delta V + \delta Q$$

Stability of thermodynamic system:

- Stable $\delta U + p\delta V - T\delta S > 0$
- Neutrally stable $\delta U + p\delta V - T\delta S = 0$
- Unstable $\delta U + p\delta V - T\delta S < 0$

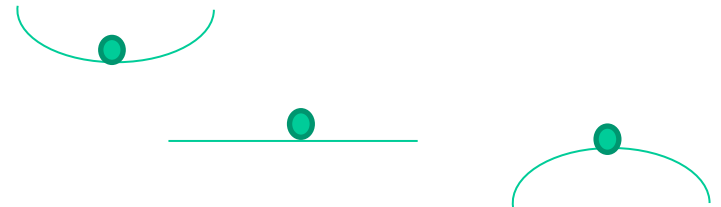

δX denote deviation of the parameter from its equilibrium value:

$$\delta X \equiv X - X_{eq}$$

System may be composed of some subsystems or may be nonuniform:

- extensive $X = X_1 + X_2 + X_3 \dots$
- intensive $X = X(x)$

Thermodynamic stability of closed systems ($\delta N = 0, \delta V = 0$)

- Energetically/volumetrically closed systems – boundary condition for external change

$$\delta U = 0 \qquad \delta V = 0$$

Thermodynamic stability condition is:

$$-T\delta S > 0 \qquad \longrightarrow \qquad \delta S < 0$$

In energetically/volumetrically closed systems in equilibrium state, the entropy of the system attains its maximal value with respect to all changes preserving internal energy

- Entropically/volumetrically closed systems – boundary condition for external change

$$\delta S = 0 \qquad \delta V = 0$$

Thermodynamic stability condition is:

$$\delta U > 0$$

In entropically/volumetrically closed systems in equilibrium state, the energy of the system attains its maximal value with respect to all changes preserving entropy

Thermodynamic stability of closed systems ($\delta N = 0$)

- Isothermal/volumetrically closed systems

$$T = \text{const} \qquad \delta V = 0$$

Thermodynamic stability condition is:

$$\delta U - T\delta S > 0 \quad \longrightarrow \quad \delta(U - TS) = \delta F > 0$$

In isothermal closed systems in the equilibrium state, Helmholtz free energy $F = U - TS$, attains its maximal value with respect to all changes preserving volume

- Isobaric/isothermal systems

$$p = \text{const} \qquad T = \text{const}$$

Thermodynamic stability condition is:

$$\delta U + p\delta V - T\delta S > 0 \qquad \delta(U - TS + pV) = \delta G > 0$$

In isothermal closed systems in the equilibrium state, Gibbs free energy $G = U - TS + pV$, attains its maximal value with respect to all changes preserving volume

Equilibrium changes of extensive functions of state

- Systems having single type of molecules (N – number of molecules)

Extensive thermodynamic functions of state ($\sim N$)

- Internal Energy U
- Enthalpy $H = U + pV$
- Helmholtz free energy $F = U - TS$
- Gibbs free energy $G = U + pV - TS$

Equilibrium changes of functions of state

$$dU = TdS - pdV + \mu dN$$

$$dH = TdS + Vdp + \mu dN$$

$$dF = -SdT - pdV + \mu dN$$

$$dG = -SdT + Vdp + \mu dN$$

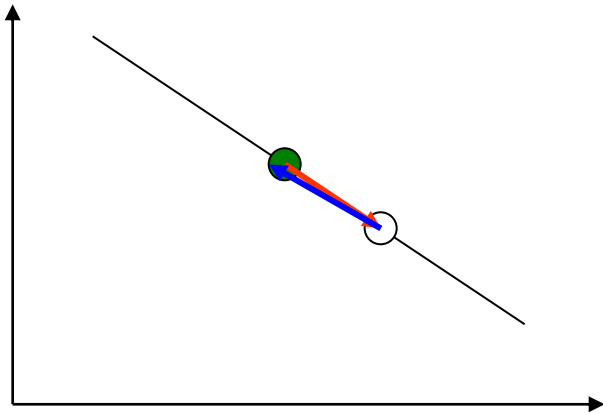

δX denote deviation of the parameter from its equilibrium value:

$$\delta X \equiv X - X_{eq}$$

Intensive functions of state

Intensive thermodynamic functions of state (independent of N) – division of extensive function of state

$$a = \frac{A}{N} \quad A = U, H, F, G$$

Independent functions of state (p, n, T) related to equation of state

$$f(p, \rho, T) = 0$$

- Gibbs free energy – is used in phase transitions theory

$$g = \frac{G}{N} = \mu$$

Gibbs free energy $g(p, n, T)$ is known as chemical potential

Equilibrium changes of Gibbs free energy

- Gibbs free energy change

$$dG = d(\mu N) = Nd\mu + \mu dN$$

$$dG = -SdT + Vdp + \mu dN$$

$$Nd\mu = -SdT + Vdp$$

$$d\mu = -\frac{S}{N}dT + \frac{V}{N}dp = -sdT + \frac{1}{n}dp$$

Equilibrium change of chemical potential is expressed by intensive function only therefore it is tailored tool for description of the system state by the change of number of particles (open systems)

$$\mu = \mu(p, T)$$

$$s = -\left(\frac{d\mu}{dT}\right)_p$$

$$v = \frac{1}{n} = \left(\frac{d\mu}{dp}\right)_T$$

Multi-phase systems

- Phase – homogenous part of the system having uniform physical and chemical properties
- Phase transition (phase transformation) – jump-like change of intensive thermodynamic properties (functions of the state) of the system

Landau classification of the phase transitions

- I order – jump-like change of the first derivatives of the chemical potential (entropy or density)
- II order – continuous change of the first derivatives of the chemical potential

I order phase transitions

- I order phase transition – jump like change of the entropy – latent heat

$$dq = T \Delta s = T_M (s_l - s_s)$$

Crystal growth

- Vapor – solid – deposition/sublimation

$$dq = T \Delta s = T_M (s_l - s_s) > 0$$

- Liquid – solid – solidification/melting

$$dq = T \Delta s = T_M (s_v - s_s) > 0$$

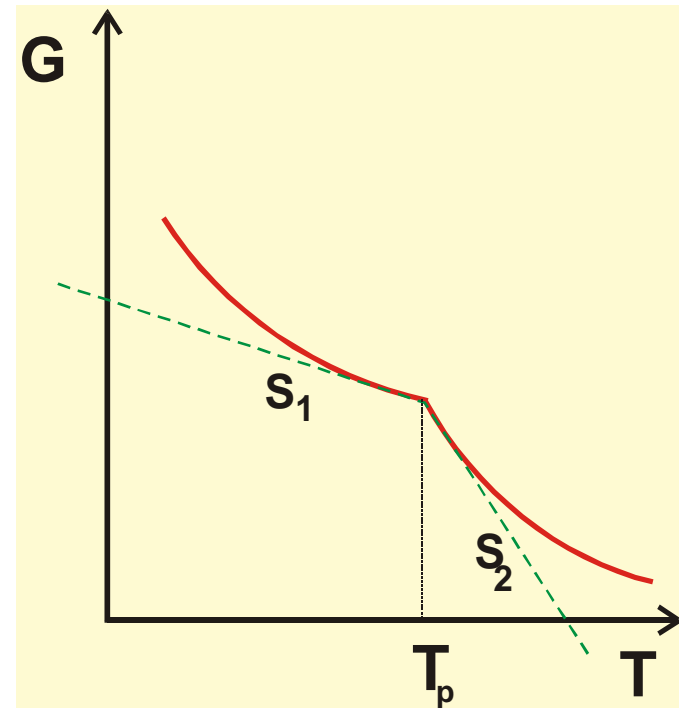

Energy barrier – coexistence of the phases

II order phase transitions

- II order phase transition – no jump like change of the entropy – latent heat

$$dq = T \Delta s = T_M (s_l - s_s) = 0$$

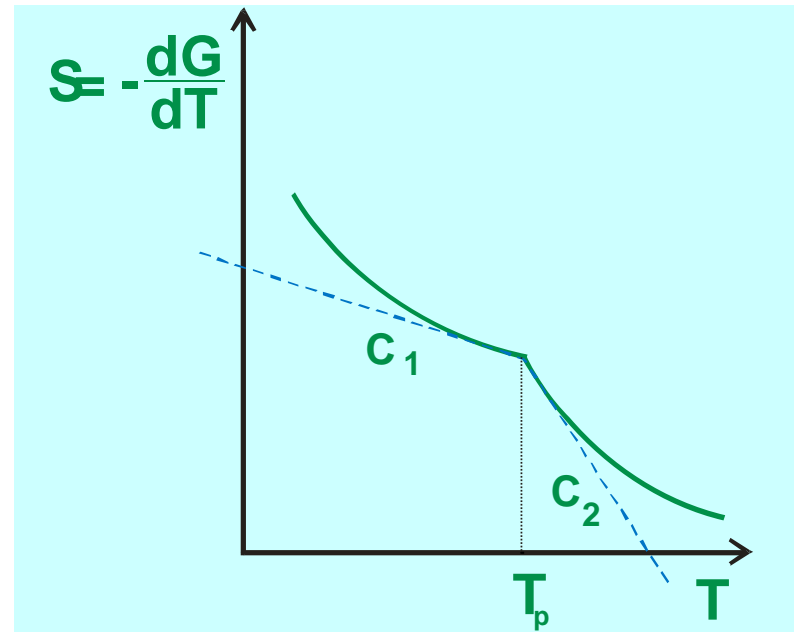
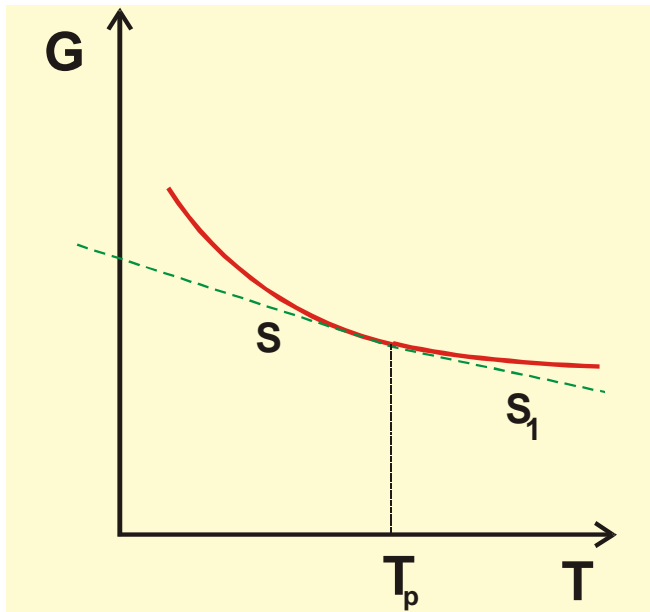

No energy barrier – no coexistence of the phases – single phase with strong fluctuations

Multi-phase systems – sums of phases

- First approximation – interface effects are neglected
- Extensive properties - sum of the component phases ($\alpha, \beta, \gamma, \dots$)

System size quantities

$$N = N_{\alpha} + N_{\beta} + N_{\gamma}$$

$$V = V_{\alpha} + V_{\beta} + V_{\gamma}$$

Thermodynamic potentials

$$U = U_{\alpha} + U_{\beta} + U_{\gamma}$$

$$H = H_{\alpha} + H_{\beta} + H_{\gamma}$$

$$F = F_{\alpha} + F_{\beta} + F_{\gamma}$$

$$G = G_{\alpha} + G_{\beta} + G_{\gamma}$$

Multi-phase systems – the constraints

$U_\alpha, V_\alpha, N_\alpha$ $p_\alpha, T_\alpha, \rho_\alpha$	$U_\beta, V_\beta, N_\beta$ $p_\beta, T_\beta, \rho_\beta$
---	---

Entire system is closed – the constraints

$$N_\alpha + N_\beta = \text{const}$$

$$V_\alpha + V_\beta = \text{const}$$

$$U_\alpha + U_\beta = \text{const}$$

Fluctuations – change of the conserved quantities

$$\delta N = \delta N_\alpha + \delta N_\beta = 0$$



$$\delta N_\alpha = -\delta N_\beta$$

$$\delta V = \delta V_\alpha + \delta V_\beta = 0$$



$$\delta V_\alpha = -\delta V_\beta$$

$$\delta U = \delta U_\alpha + \delta U_\beta = 0$$



$$\delta U_\alpha = -\delta U_\beta$$

Multi-phase systems – equilibrium conditions

- **Mechanical equilibrium**

$$p_{\alpha}\delta V_{\alpha} + p_{\beta}\delta V_{\beta} \geq 0$$

$$\delta V_{\alpha} = -\delta V_{\beta}$$



$$p_{\alpha} = p_{\beta}$$

- **Thermal equilibrium**

$$T_{\alpha}\delta S_{\alpha} + T_{\beta}\delta S_{\beta} \geq 0$$

$$\delta S_{\alpha} = -\delta S_{\beta}$$



$$T_{\alpha} = T_{\beta}$$

- **Chemical equilibrium**

$$\mu_{\alpha}\delta N_{\alpha} + \mu_{\beta}\delta N_{\beta} \geq 0$$

$$\delta N_{\alpha} = -\delta N_{\beta}$$



$$\mu_{\alpha} = \mu_{\beta}$$

Multi-phase single component systems – number of degrees of freedom – phase diagrams

- **Two-phase equilibria**

$$\mu_{\alpha}(p, T) = \mu_{\beta}(p, T) \quad \Rightarrow$$

- 1 equation
- 2 variables



- $d = 1$
- line

- **Three phase equilibria**

$$\mu_{\alpha}(p, T) = \mu_{\beta}(p, T) = \mu_{\gamma}(p, T) \quad \Rightarrow$$

- 2 equations
- 2 variables



- $d = 0$
- point

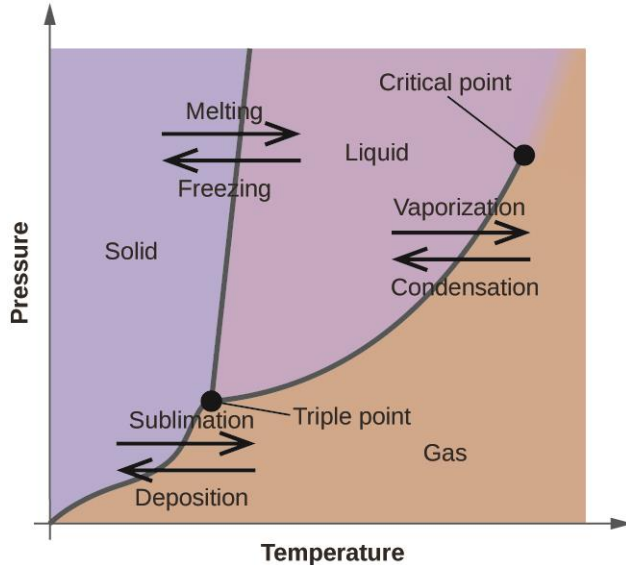

- **Vapor (gas) – filling the entire accessible volume**
- **Liquid – filling fraction of the accessible volume (conservation of the volume)**
- **Solid – preserving the shape**

*Stamatis Muratidis Chemistry
Ocean 540 Phase diagrams*

Single component system – vapor-solid equilibrium

- **Chemical equilibrium**

$$\mu_s(p, T) = \mu_v(p, T)$$

- **Isothermal, pressure induced chemical potential change**

$$d\mu = -sdT + vdp$$

- **Ideal gas approximation**

$$p = nRT = \frac{RT}{v} = \frac{\rho RT}{M} \qquad \mu_v(p, T) = \mu_v(p_o, T) + RT \ln \left(\frac{p}{p_o} \right)$$

- **Solid – isothermal compressibility**

$$\rho(p) = \rho_o(1 + \alpha p) \qquad \alpha \equiv \frac{1}{V} \left(\frac{\partial V}{\partial p} \right) = -\frac{1}{\rho} \left(\frac{\partial \rho}{\partial p} \right)_{T,T}$$

$$\mu_s(p, T) = \mu_s(p_o, T) + v_o(p - p_o)[1 - \alpha(p - p_o)/2]$$

p_o – reference pressure - 1 bar

Single component system – vapor-solid equilibrium – Van t'Hoff relation

- Solid density is much higher than the vapor

$$\rho_s \gg \rho_v$$

- Chemical potential dependence

$$\mu_v(p, T) = \mu_v(p_o, T) + RT \ln \left(\frac{p}{p_o} \right)$$

$$\mu_s(p, T) \cong \text{const}(p)$$

- Thermodynamic potentials

$$\mu_{s,v} = h_{s,v} - TS_{s,v}$$

- Pressure temperature dependence (Van t'Hoff relation)

$$p = p_o \exp \left(-\frac{\Delta h}{RT} + \Delta s \right)$$

$$\Delta h, \Delta s \sim \text{const}(T)$$

Example – saturated Ga vapor pressure

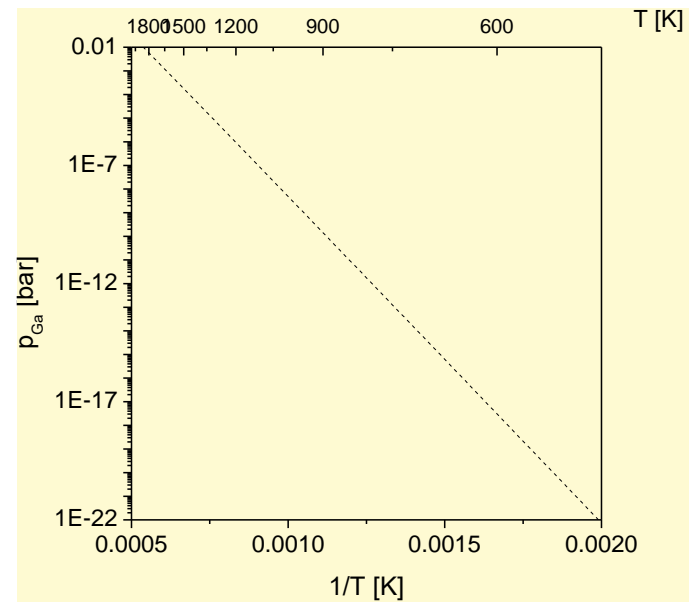

Single component system – liquid - solid equilibrium – Clausius-Clapeyrons relation

- Solid and liquid densities are comparable

$$\rho_s \sim \rho_l$$

- Chemical potential equality

$$\mu_l(p_1, T_1) = \mu_s(p_1, T_1)$$

$$\mu_l(p_2, T_2) = \mu_s(p_2, T_1)$$

- Chemical potentials difference along equilibrium line

$$d\mu_{s,l} = \mu_{s,l}(2) - \mu_{s,l}(1) = -s_{s,l}dT + v_{s,l}dp$$

- Pressure temperature dependence
(Clausius-Clapeyron relation)

$$-\Delta s_{s,l}dT + \Delta v_{s,l}dp = 0 \quad \longrightarrow \quad \frac{dp}{dT} = \frac{\Delta s}{\Delta v} = \frac{s_l - s_s}{v_l - v_s} = \frac{Q}{T\Delta v}$$

$$Q \equiv T\Delta s \text{ – latent heat of fusion (melting)}$$

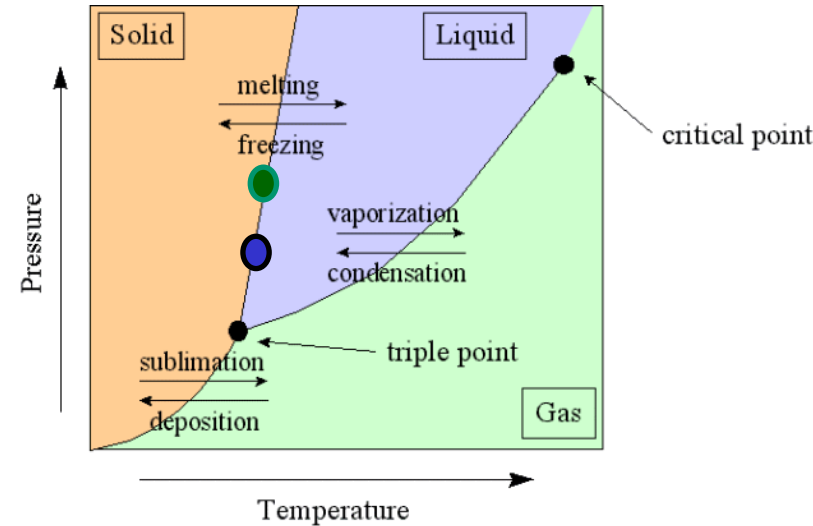

Ocean 540 Phase diagrams

Single component systems – vapor-liquid-solid equilibria

- Clausius – Clapeyron relation

$$\frac{dp}{dT} = \frac{\Delta s}{\Delta v} = \frac{s_l - s_s}{v_l - v_s} = \frac{Q}{T\Delta v}$$

$$Q \equiv T\Delta s > 0$$

- Van t'Hoff relation

$$p = p_o \exp\left(-\frac{\Delta h}{RT} + \Delta s\right)$$

Al

$$\frac{dp_m}{dT} > 0$$

$$v_l - v_s > 0$$

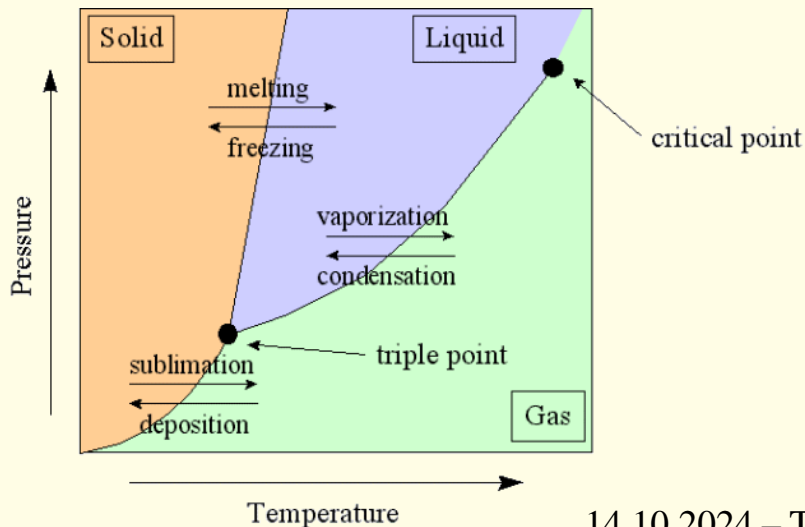

H₂O

$$\frac{dp_m}{dT} > 0$$

$$v_l - v_s < 0$$

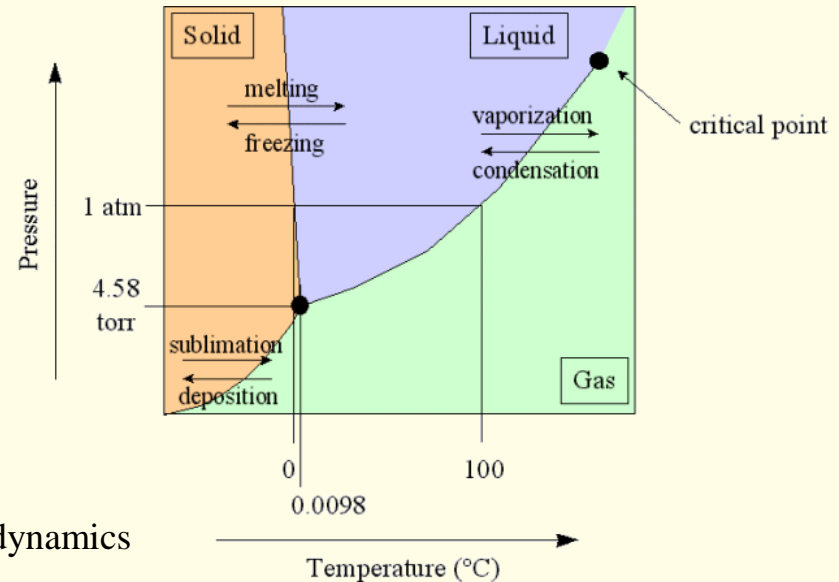

Single component systems – Helmholtz free energy (thermodynamic potential)

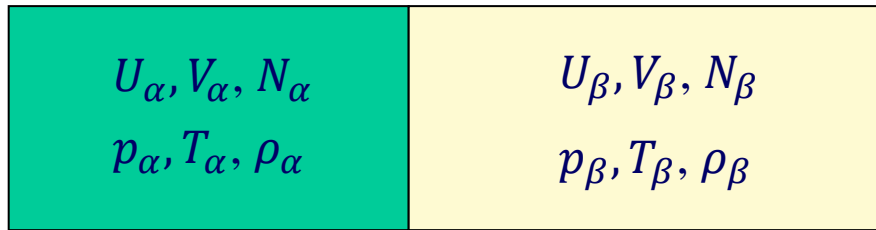

$$p_\alpha \delta V_\alpha + p_\beta \delta V_\beta \geq 0$$

$$\delta V_\alpha = -\delta V_\beta \quad p_\alpha = p_\beta$$

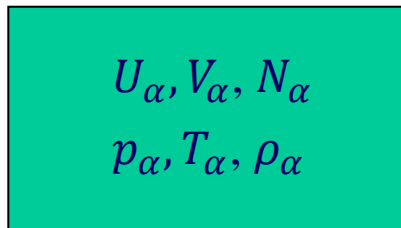

$$p_\alpha = p_{ext} = \frac{G}{S}$$

G - force

S - area

$$dF = -SdT - pdV + \mu dN \quad \longrightarrow \quad p = -\left(\frac{\partial F}{\partial V}\right)_{N,T} = -\left(\frac{\partial f}{\partial v}\right)_T$$

In isothermal closed systems in the equilibrium state, Helmholtz free energy $F = U - TS$, attains its maximal value with respect to all changes preserving volume

$$\delta(U - TS) = \delta F > 0 \quad p_{ext} = -\left(\frac{\partial f}{\partial v}\right)_T \quad \left(\frac{\partial^2 f}{\partial v^2}\right)_T > 0$$

Single component systems – vapor-liquid-solid equilibria

The conditions of thermodynamic stability in presence of external pressure

$$p_{ext} = - \left(\frac{\partial f}{\partial v} \right)_T \quad \left(\frac{\partial^2 f}{\partial v^2} \right)_T = - \left(\frac{\partial p}{\partial v} \right)_T > 0$$

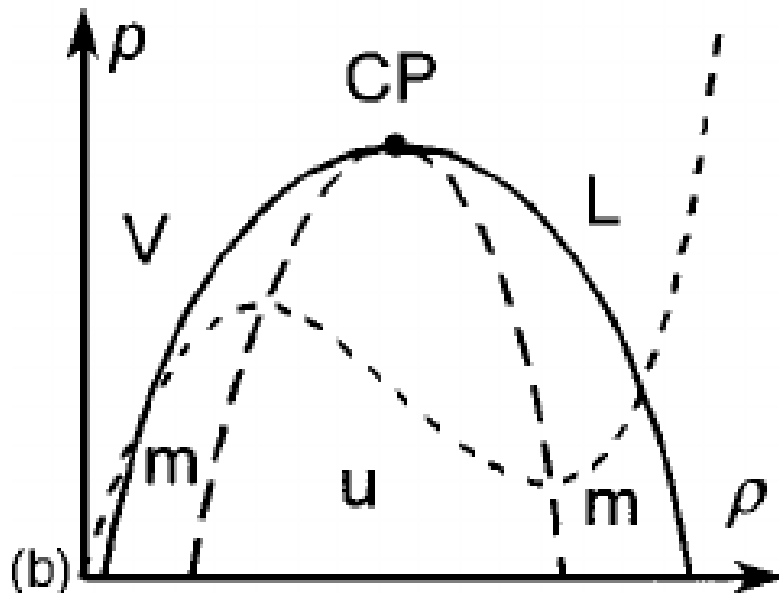

$$p_{ext} = p(v, T)$$

Spinodal – line dividing metastable (m) and unstable (regions)

A.R. Imre & T. Kraska, J. Chem. Phys. 122 (2005)064507

Two component system: solid – liquid equilibrium

$$x_s \equiv \frac{N_1}{N_1 + N_2}$$

- Crystallization at constant pressure, $p = \text{const}$
- Solid phases have the same symmetry – potentially fully miscible

$$\mu_l^1(p, T, x_l) = \mu_s^1(p, T, x_s)$$

$$\mu_l^2(p, T, x_l) = \mu_s^2(p, T, x_s)$$

$x_l(T), x_s(T)$ - lines

- **At the edges: $x = 0$ or $x = 1$ - points**

$$\mu_l^1(p, T, 1) = \mu_s^1(p, T, 1)$$

$$\mu_l^2(p, T, 0) = \mu_s^2(p, T, 0)$$

- **Segregation coefficient**

$$k \equiv \frac{dx_s(T)}{dx_l(T)} \cong \frac{x_s(T)}{x_l(T)}$$

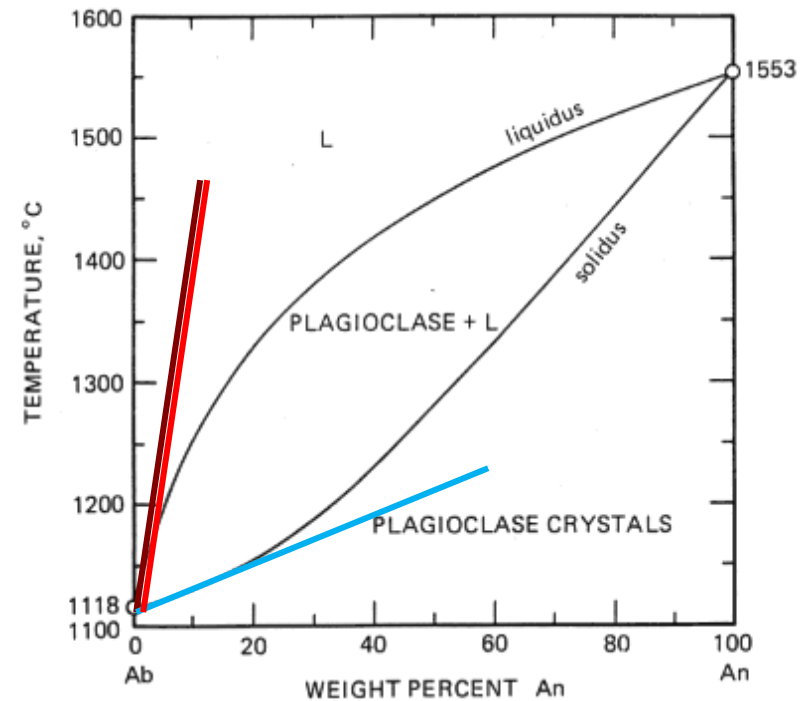

- **Liquidus slope**

$$m_l \equiv \frac{dx_l(T)}{dT} \cong \frac{x_l(T)}{T(x_l) - T(0)}$$

All solid solutions could be obtained.

Two component system – liquid-solid – eutectic diagram

- Solid phases have different symmetry – immiscible

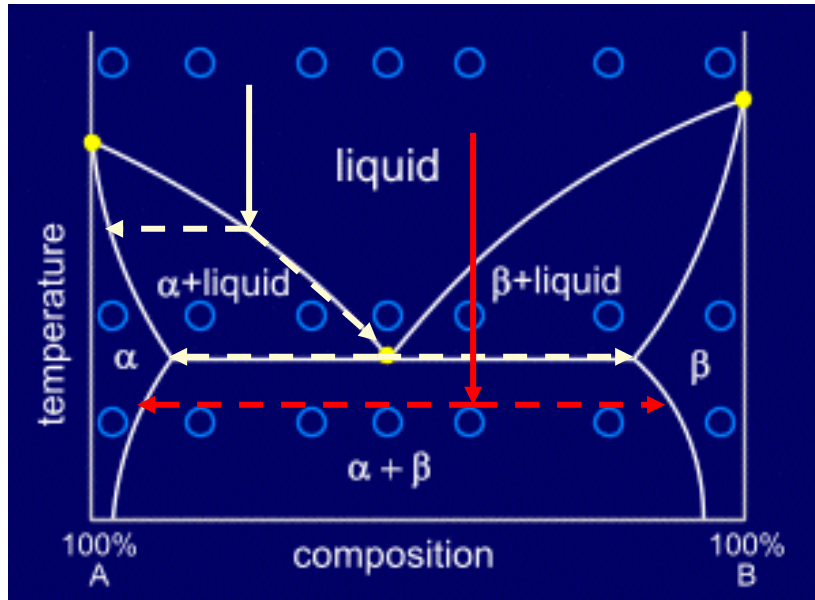

- **Cooling:**
 - crystallization of α phase (or β phase)
 - krystalizujemy strukturę wstęgową - mieszaninę faz α oraz β

- **Spinodal:**
 - unstable thermodynamically
 - nonuniform system

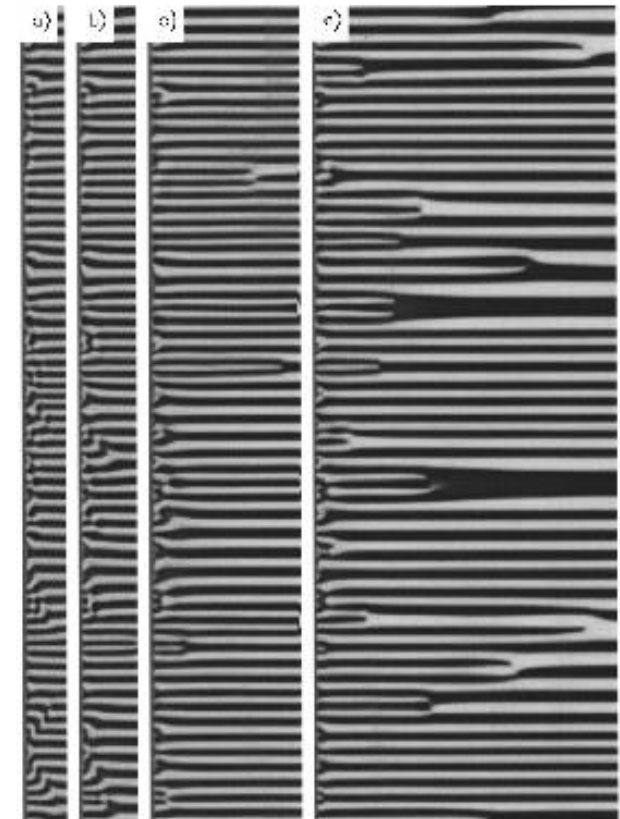

*K.R. Elder, J.D. Gunton & M. Grant,
Phys. Rev E 54 (1996) 6476*

Uniform solid cannot be obtained

Two component system – liquid-solid – peritectic diagram

- **Incongruent melting point** – solid and liquid phase chemical composition is different
- **Peritectic point** – one solid in equilibrium with the liquid

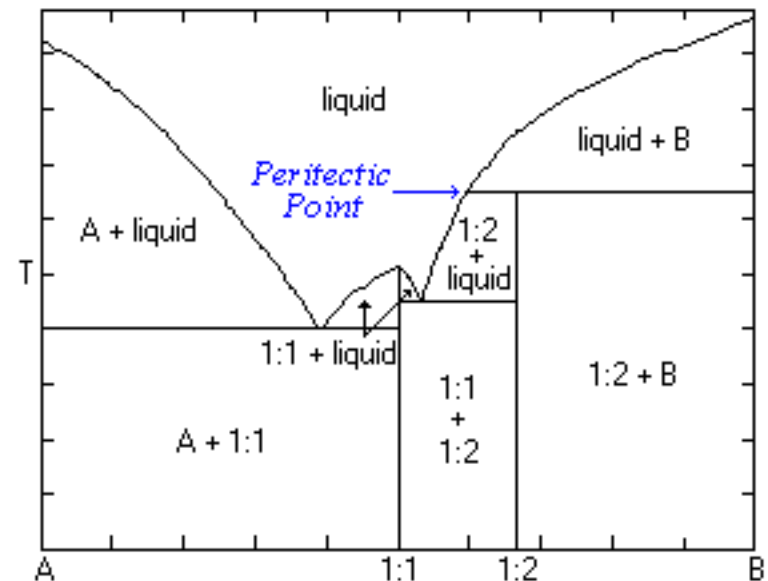
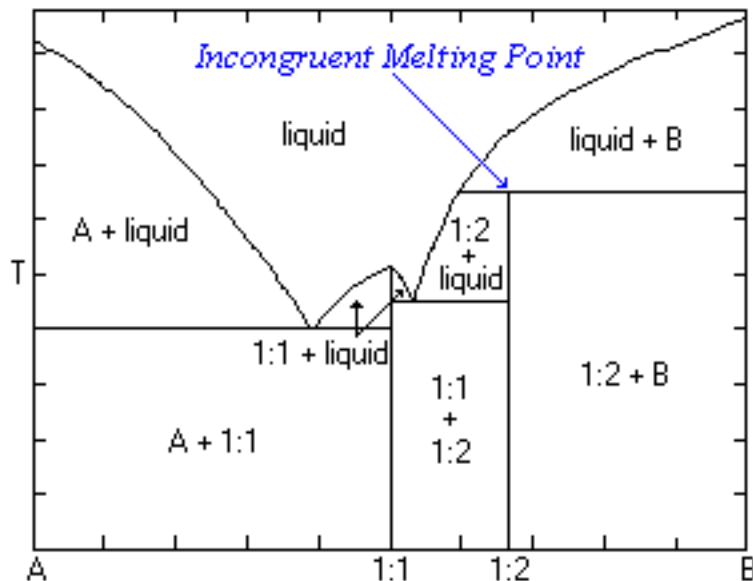

Ocean 540 Phase diagrams

Solid of predetermined composition could be crystallized

Two component system – liquid-solid – congruent melting point

- Congruent melting point – solid and liquid phase chemical composition are identical

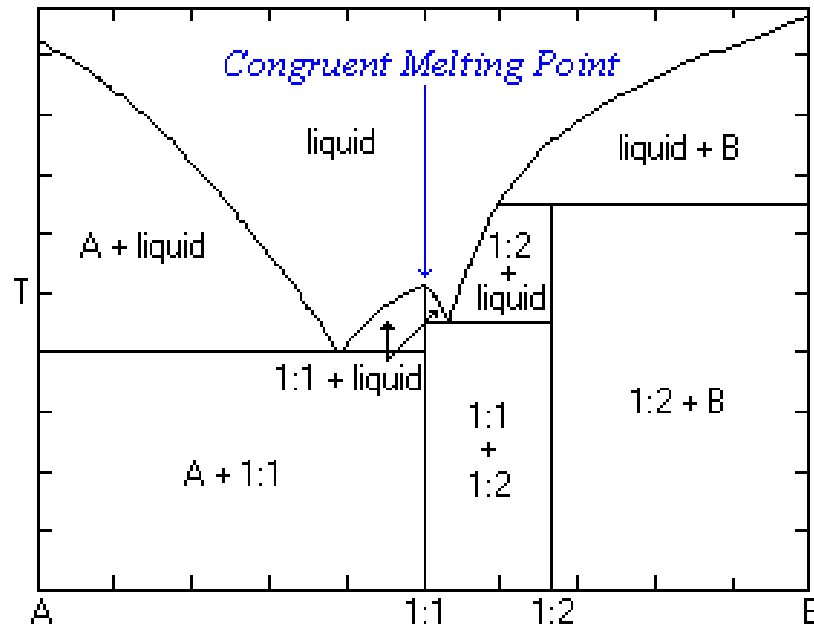

Ocean 540 Phase diagrams

Examples – III-V compound semiconductor phase diagram

GaAs – phase diagram

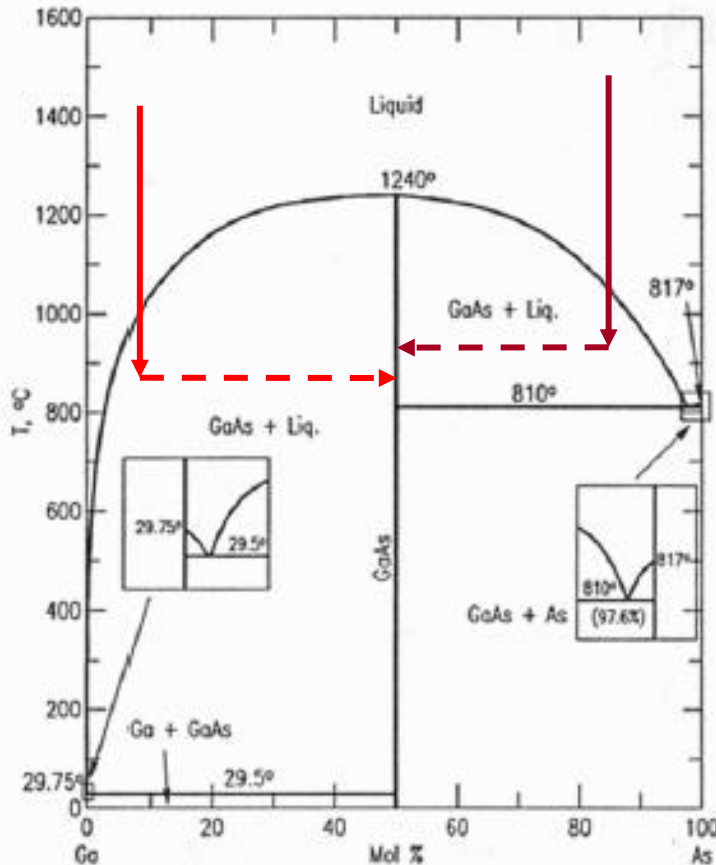

- **GaAs is stoichiometric compound, more stable than the pure elements**
- **GaAs crystallization from As solution in liquid Ga**
- **GaAs crystallization from Ga solution in liquid As**
- **Eutectics in Ga- and As-rich regions**

Ocean 540 Phase diagrams

Chemical compound: GaAs – sublimation

- **Chemical reaction:**



- **Chemical stability condition (no chemical potential associated with Ga and As separately)**

$$\mu_{\text{GaAs}} \delta N_{\text{GaAs}} + \mu_{\text{Ga}} \delta N_{\text{Ga}} + \mu_{\text{As}_2} \delta N_{\text{As}_2} \geq 0$$

- **Chemical equilibrium condition:**

$$\mu_{\text{GaAs}} = \mu_{\text{Ga}} + \frac{1}{2} \mu_{\text{As}_2}$$

- **Sublimation (vaporization) enthalpy (at normal conditions)**

$$\Delta h_{\text{GaAs}}^{\text{sub}} = h_{\text{Ga}} + \frac{1}{2} h_{\text{As}_2} - h_{\text{GaAs}}$$

- **Sublimation (vaporization) entropy (at normal conditions)**

$$\Delta S_{\text{GaAs}}^{\text{sub}} = S_{\text{Ga}} + \frac{1}{2} S_{\text{As}_2} - S_{\text{GaAs}}$$

GaAs – simple Van t'Hoff relation

- **Ideal gas approximation:**

$$p = nRT = \frac{RT}{v} = \frac{\rho RT}{M} \qquad \mu_v(p, T) = \mu_v(p_o, T) + RT \ln \left(\frac{p}{p_o} \right)$$

- **Chemical stability gives relation for chemical potential**

$$\mu_{Ga}(p_o, T) + \frac{1}{2} \mu_{As_2}(p_o, T) + RT \ln \left(\frac{p_{Ga} p_{As_2}^{1/2}}{p_o^{3/2}} \right) = \mu_{GaAs}(p, T) \cong \mu_{GaAs}(p_o, T)$$

- **Van t'Hoff relations obtained via sublimation enthalpy and entropy**

$$p_{Ga} p_{As_2}^{1/2} = p_o^{3/2} \exp \left(-\frac{\Delta h_{GaAs}^v}{RT} + \Delta S_{GaAs}^v \right)$$

Chemical compound: GaAs – sublimation (complex gas phase)

- **Chemical reaction:**



- **Vapor phase reaction**



- **Chemical equilibrium condition:**

$$\mu_{\text{As}_2} \delta N_{\text{As}_2} + \mu_{\text{As}_4} \delta N_{\text{As}_4} \geq 0$$

- **Pressure equilibrium – equilibrium constant of reaction**

$$\frac{p_{\text{As}_4}}{p_{\text{As}_2}^{1/2} p_o^{1/2}} = C(T)$$

- **Equilibrium constant of reaction C(T) – independent of pressure**

$$C(T) = \exp\left(-\frac{\Delta\mu_{\text{As}}^v(T)}{RT}\right) = \exp\left(-\frac{\Delta h_{\text{As}}^v}{RT} + \Delta s_{\text{As}}^v\right)$$

GaAs – phase diagrams

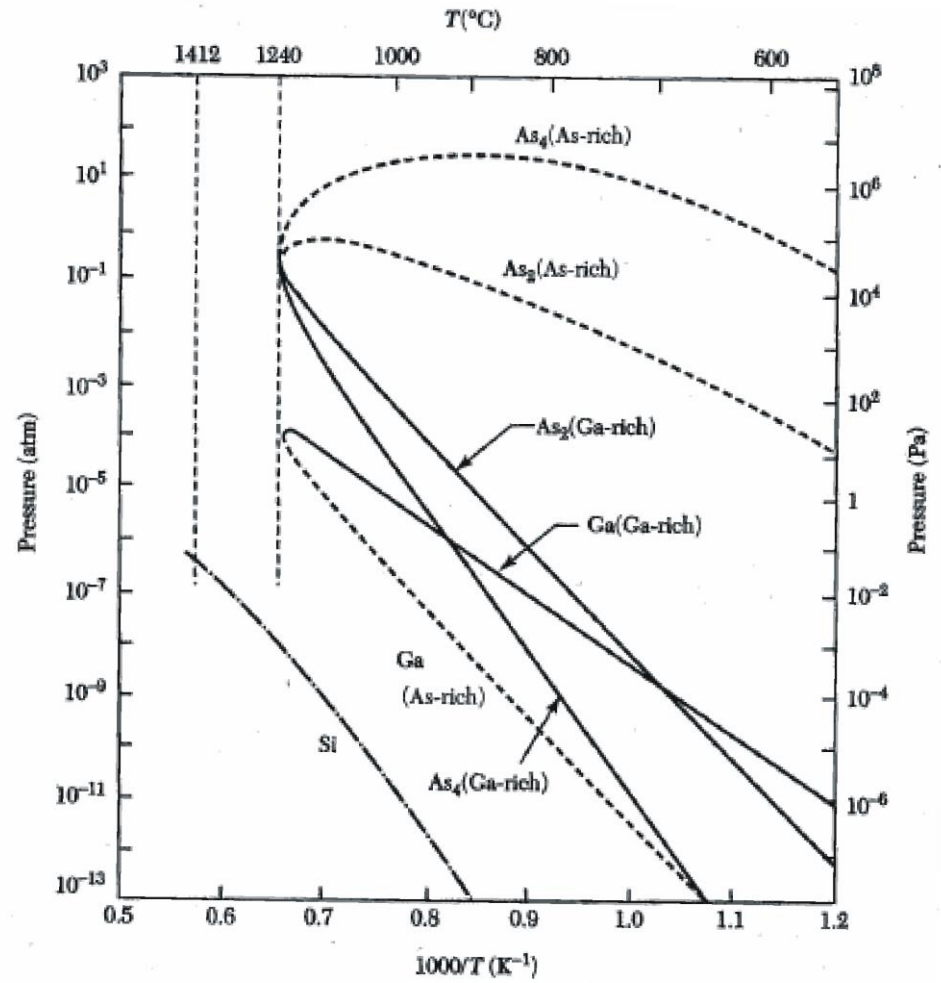
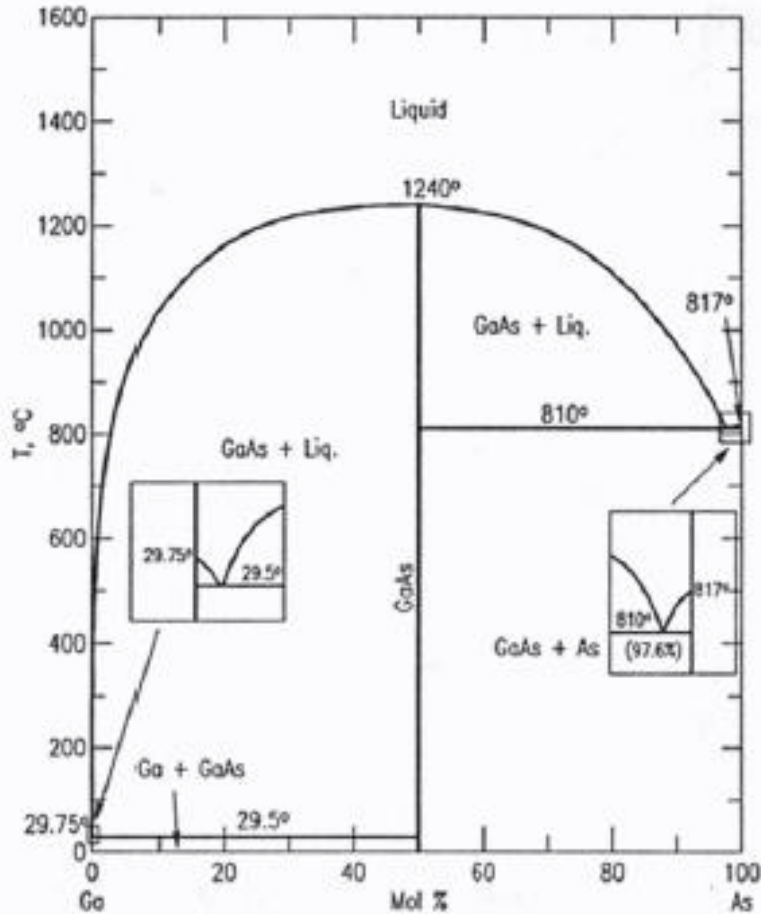

Ocean 540 Phase diagrams

GaN – enthalpy of formation

- **Chemical reaction:**



- **Chemical equilibrium condition:**

$$\mu_{\text{GaN}}(p, T) = \mu_{\text{Ga}}(l) + \frac{1}{2} \mu_{\text{N}_2}(p_o, T) + RT \ln \left(\frac{p_{\text{N}_2}^{1/2}}{p_o^{1/2}} \right)$$

- **Enthalpy and entropy of formation (at normal conditions)**

$$\Delta h_{\text{GaN}}^{\text{form}} = h_{\text{Ga}} + \frac{1}{2} h_{\text{N}_2} - h_{\text{GaN}} \qquad \Delta S_{\text{GaN}}^{\text{form}} = S_{\text{Ga}} + \frac{1}{2} S_{\text{N}_2} - S_{\text{GaN}}$$

- **Van t'Hoff relation**

$$p_{\text{N}_2} = p_o \exp \left(-\frac{2\Delta h_{\text{GaN}}^{\text{form}}}{RT} + 2\Delta S_{\text{GaN}}^{\text{form}} \right)$$

GaN – solid-liquid equilibrium

$$x = \frac{n_N}{n_{Ga} + n_N}$$

- **Chemical equilibrium condition:**

$$\mu_{GaN}(p, T) = \mu_{Ga-l}(x, T) + \mu_{N-l}(x, T)$$

- **Ideal solution approximation**

$$\mu_{GaN}(p, T) = \mu_{Ga-l}(0, T) + RT \ln(x)$$

- **Dissolution relation**

$$x = x_o \exp\left(-\frac{\Delta h_{GaN}^{dis}}{RT} + \Delta S_{GaN}^{dis}\right)$$

- **Enthalpy and entropy of dissolution**

$$\Delta h_{GaN}^{dis} = h_{Ga} + h_N - h_{GaN}$$

$$\Delta S_{GaN}^{dis} = S_{Ga} + S_N - S_{GaN}$$

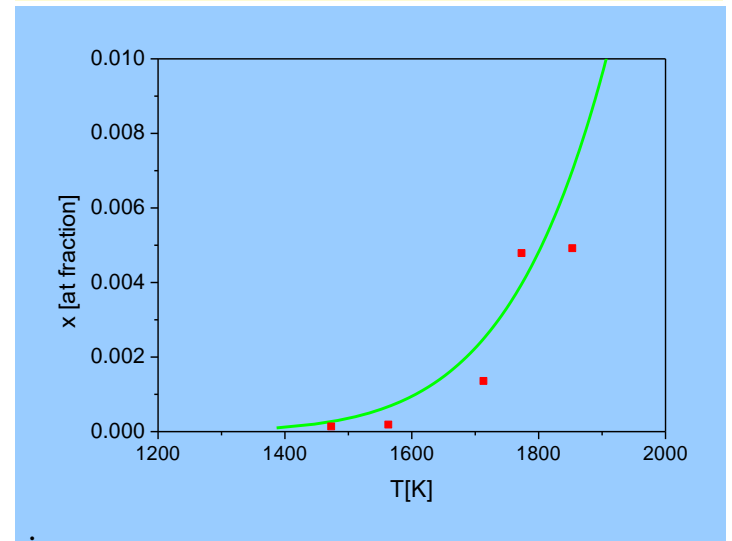
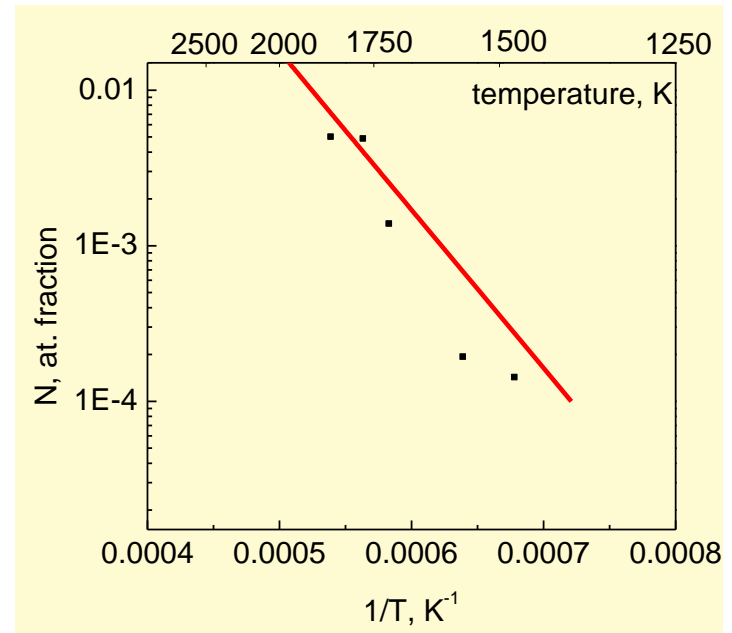

GaN – vapor-solid-liquid equilibrium

- **Solid-vapor equilibrium (ideal gas):**

$$\mu_{\text{GaN}}(p, T) = \mu_{\text{Ga-l}}(0, T) + \frac{1}{2} \mu_{\text{N}_2}(p_o, T) + RT \ln \left(\frac{p_{\text{N}_2}^{1/2}}{p_o^{1/2}} \right)$$

$$p_{\text{N}_2} = p_o \exp \left(-\frac{2\Delta h_{\text{GaN}}^{\text{form}}}{RT} + 2\Delta S_{\text{GaN}}^{\text{form}} \right)$$

- **Solid – liquid equilibrium (ideal solution):**

$$\mu_{\text{GaN}}(p, T) = \mu_{\text{Ga-l}}(0, T) + RT \ln(x)$$

$$x = x_o \exp \left(-\frac{\Delta h_{\text{GaN}}^{\text{dis}}}{RT} + \Delta S_{\text{GaN}}^{\text{dis}} \right)$$

$$x = \frac{n_{\text{N}}}{n_{\text{Ga}} + n_{\text{N}}}$$

GaN – vapor-solid-liquid equilibrium - diagrams

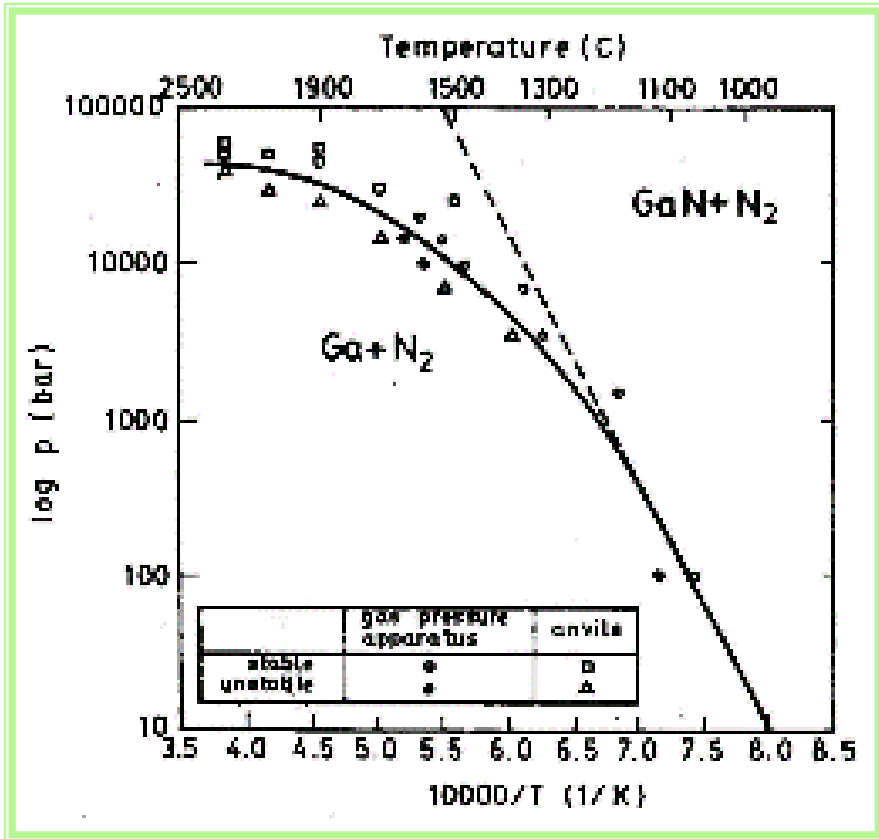

J. Karpinski et al. J. Cryst. Growth 66 (1984) 1

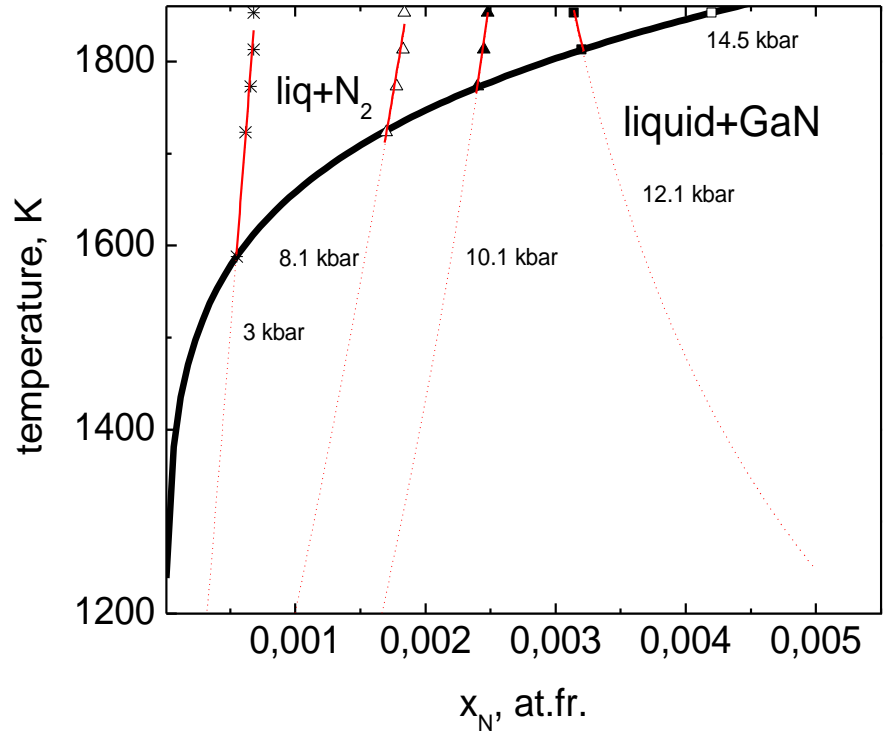

I. Grzegory, Habilitation, IF PAN 2008

Multiphase two component systems – phase diagrams

- **Two phases**

$$\mu_{\alpha}^1(p, T, x_{\alpha}) = \mu_{\beta}^1(p, T, x_{\beta})$$

$$\mu_{\alpha}^2(p, T, x_{\alpha}) = \mu_{\beta}^2(p, T, x_{\beta})$$

$d = 2$ \Rightarrow **surface**

- **Three phases (additional equations)**

$$\mu_{\alpha}^1(p, T, x_{\alpha}) = \mu_{\gamma}^1(p, T, x_{\gamma})$$

$$\mu_{\alpha}^2(p, T, x_{\alpha}) = \mu_{\gamma}^3(p, T, x_{\gamma})$$

$d = 1$ \Rightarrow **line**

- **Four phases (additional equation)**

$$\mu_{\alpha}^1(p, T, x_{\alpha}) = \mu_{\delta}^1(p, T, x_{\delta})$$

$$\mu_{\alpha}^2(p, T, x_{\alpha}) = \mu_{\delta}^3(p, T, x_{\delta})$$

$d = 0$ \Rightarrow **point**

Multi-phase multi-component systems – degrees of freedom –Gibbs rule

- **Phases (m) components (q)**

$$\mu_1^\alpha(p, T, x_1^\alpha, \dots, x_1^{q-1}) = \mu_2^\alpha(p, T, x_2^\alpha, \dots, x_2^{q-1}) = \dots = \mu_m^\alpha(p, T, x_m^\alpha, \dots, x_m^{q-1})$$

$$\mu_1^\beta(p, T, x_1^\alpha, \dots, x_1^{q-1}) = \mu_2^\beta(p, T, x_2^\alpha, \dots, x_2^{q-1}) = \dots = \mu_m^\beta(p, T, x_m^\alpha, \dots, x_m^{q-1})$$

$$\mu_1^q(p, T, x_1^\alpha, \dots, x_1^{q-1}) = \mu_2^q(p, T, x_2^\alpha, \dots, x_2^{q-1}) = \dots = \mu_m^q(p, T, x_m^\alpha, \dots, x_m^{q-1})$$

- **(m-1)q equation**
- **(q-1)m concentrations (x₁, x₂,...) and 2 intensive parameters (p,T)**

Number of degrees of freedom d (Gibbs phase rule)

$$d = (q - 1)m - (m - 1)q + 2 = q - m + 2$$

Literature

- H.N.S. Wergeland, D. ter Haar, *Elements of Thermodynamics*, Addison-Wesley 1966
- E.A. Guggenheim, *Thermodynamics. An Advanced Treatment for Chemists and Physicists*, seventh edition. (1985). ISBN 0-444-86951-4
- B. Massalski, H. Okamoto, P.R. Subramanian, L. Kacprzak, *Binary Alloy Phase Diagrams*, 2nd Edition, ISBN: 978-0-87170-403-0
- J. Dunning-Davies, *Concise Thermodynamics: Principles and Applications*. Horwood Publishing. 1997 ISBN 978-1-8985-6315-0.
- S. Porowski, I. Grzegory and S. Krukowski, in *Mater. Res. Soc. Symp. Proc. Vol. 499, p. 349*
- S. Porowski and I. Grzegory, in *Semicond. & Semimetal*. Vol. 55 p. 354
- Krukowski-S; Grzegory-L; Bockowski-M; Lucznik-B; Suski-T; Nowak-G; Borysiuk-J; Wroblewski-M; Leszczynski-M; Perlin-P; Porowski-S; Weyher-JL
[Growth of AlN, GaN and InN from the solution](#)
International-Journal-of-Materials-and-Product-Technology. 2005; 22(1-3): 226-61
- Grzegory I, Krukowski S, Leszczynski M, Perlin P, Suski T, Porowski S
[The application of high pressure in physics and technology of III-V nitrides](#)
Acta Physica Polonica A Supplement vol 100 Dec. 2001 pp.57-109
- Grzegory I, Jun J, Bockowski M, Krukowski S, Wroblewski M, Lucznik B, Porowski S
[III-V nitrides-thermodynamics and crystal growth at high N₂ pressure.](#)
Journal of Physics & Chemistry of Solids, vol.56, no.3-4, March-April 1995, pp.639-47